

LEVETATOR

Installation Instructions

Fitting your Levetator is straight-forward and should take about $1/2$ to 1 hour.

Levetators are designed to be mounted on the tank roof (if your tank hasn't got a roof you will need an adaptor bracket - see overleaf).

There is no need to enter the tank; take care not to drop anything inside.

Follow these simple steps

See Special Cases overleaf for barrel-shaped tanks, steep roofs, tanks without roofs, mounting away from manhole

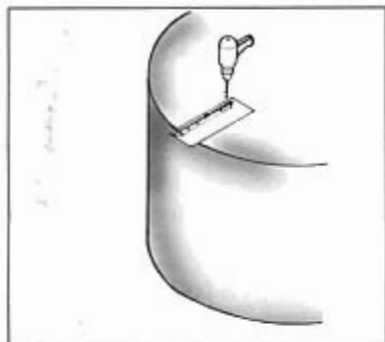

1. Drill Holes

Choose the best place for the Levetator on your tank for visibility, away from pipes, etc.

Drill two holes in the roof for the cords, and two holes for the fixing screws, using the template below to mark positions. Drilling in sheetmetal, fibreglass, or plastic is straight-forward, but concrete requires a masonry drill.

A small drill will do, as the cord holes can be easily enlarged with a cold chisel.

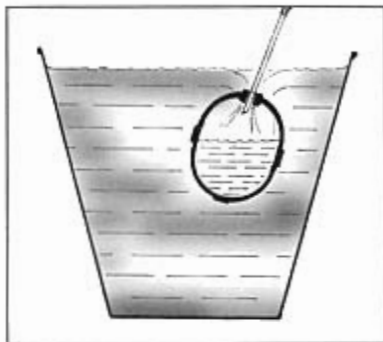

2. Fill Float

The float has to be filled with water (to provide enough weight for correct balance).

Unscrew "cordwangler" (eye screw), insert the straw provided just inside the hole (about 20mm only), submerge the float in a bucket of water, and suck the air out.

Water will rush in around the straw until only a small bubble of air remains inside the float.

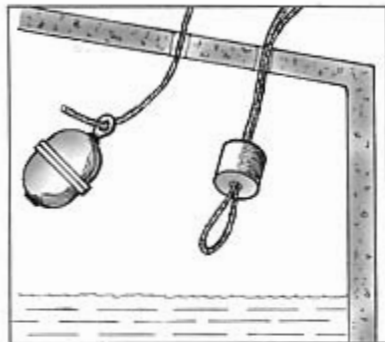

3. Thread Cords

Poke the cordwangler through the hole drilled for the float cord and screw the float back on to it.

Untie the pair of cords from the galvanised counterpoise, poke them through the other hole drilled in the roof, back through the counterpoise and re-tie the knot.

Let the float and counterpoise down gently. Don't let the cords slip through pulleys!

TEMPLATE

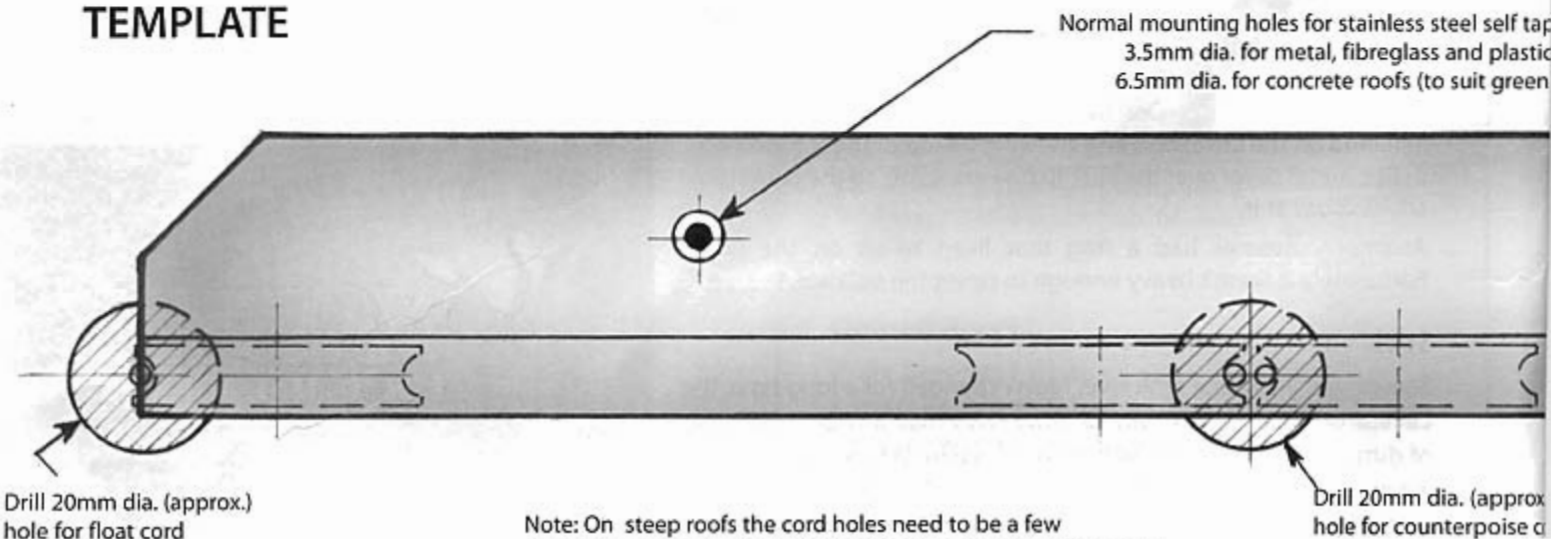

Normal mounting holes for stainless steel self tap
3.5mm dia. for metal, fibreglass and plastic
6.5mm dia. for concrete roofs (to suit green

Drill 20mm dia. (approx.)
hole for float cord

Note: On steep roofs the cord holes need to be a few millimetres closer to the tank edge to compensate for the angle and thus prevent chafing.

Drill 20mm dia. (approx.)
hole for counterpoise

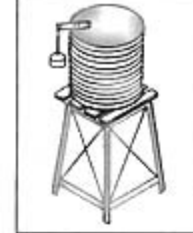
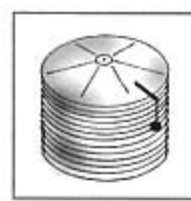
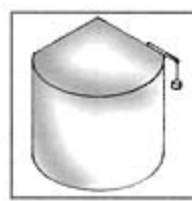

Fits all Tanks

Concrete, Corrugated Iron, Fibreglass, Plastic, Plastic-lined Timber or Steel

Any diameter

Any Height

Up to 3 metres with standard Levetator, more with longer cords (can be supplied as a special)



See our full range of products at www.yaktek.com.au

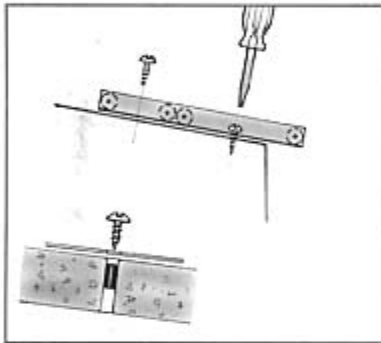

4. Mount Levetator

First, shorten the float cord to suit your tank height & roof slope; the correct knot is a bowline. With the counterpoise resting on the bottom the float should hang just below the roof. Leave a little extra cord to allow for final adjustment.

Fix the Levetator to the tank roof using the stainless steel self-tapping screws provided. The screws go directly into the sheetmetal, fibreglass, and plastic, but for concrete you will need masonry plugs, available from your local hardware store.

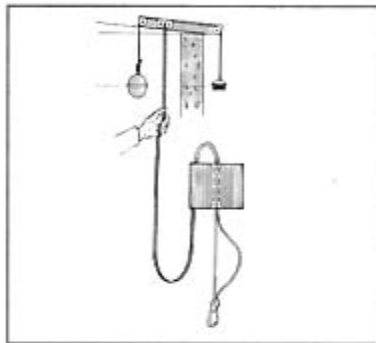

5. Adjust Indicator & Test

The indicator should now be hanging below the water level. Adjust the indicator's position by shortening its cord; a "figure of 8 knot" is best. This may take a couple of attempts. The correct position is when the reflective red band is level with the water.

Check correct operation by lifting the float up slowly by hand (as if the tank was filling). The indicator should follow suit, pulled by the weight of the counterpoise. When released, the float will descend until it rests again on the water, half-submerged.

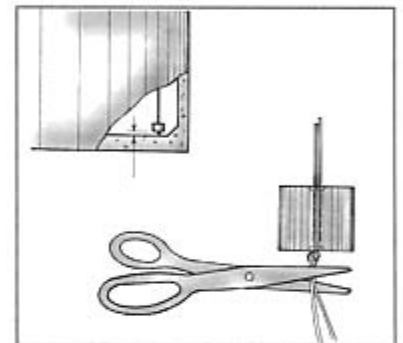

6. Final Adjustment

The float and indicator should now match the water level. With a full tank, the float should be hanging from its cord, half-submerged, and the counterpoise should be just touching the bottom.

Usually, minor corrections are necessary. After adjusting the knots, trim off the excess cord. Ideally, the cut ends of the cords should be seared with a match to prevent fraying.

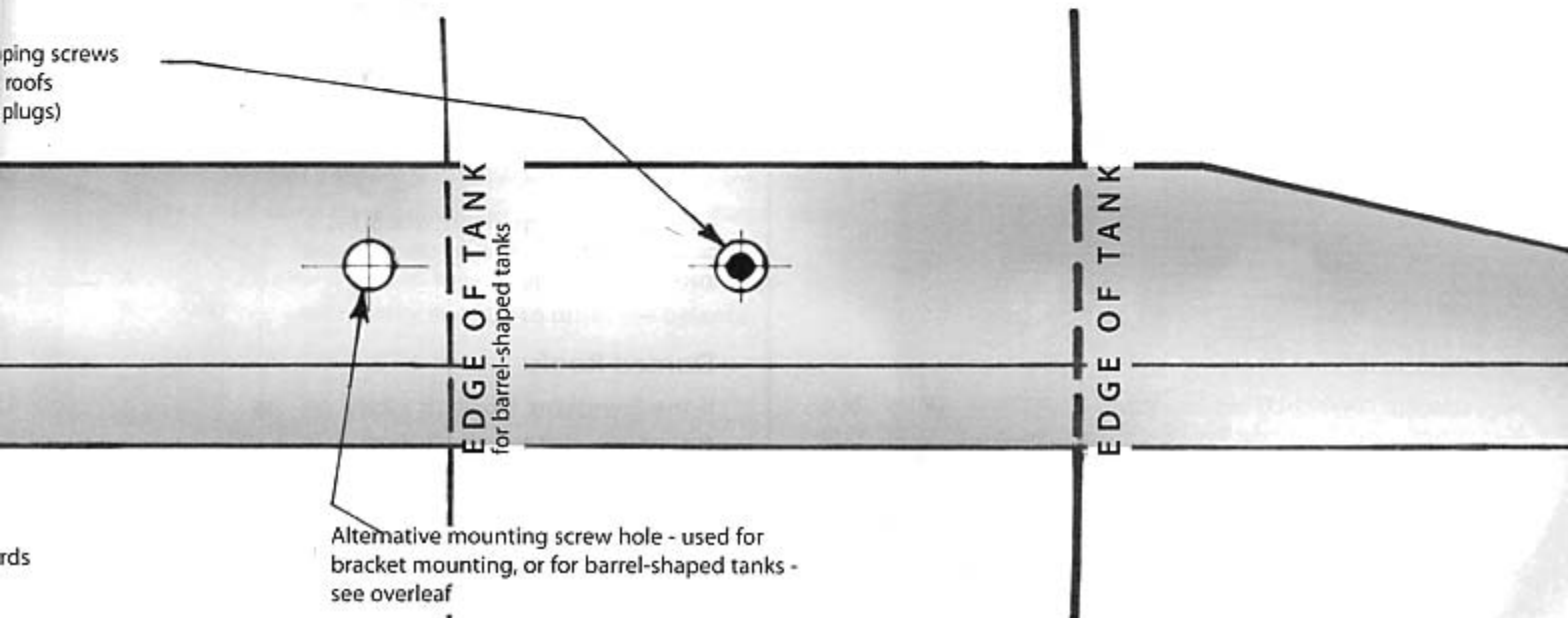

SPECIAL CASES

Mounting away from manhole

Obviously it is easiest to mount the Levetator beside the manhole, but it isn't very difficult to mount it elsewhere.

When you get to the stage where you have to poke the cords down through the holes and tie on the float and counterpoise, you don't need to climb inside the tank.

Instead, take a slender stick and hammer a nail through one end. This can then be passed through the manhole and used as a "hook" to catch the cord and draw it towards you.

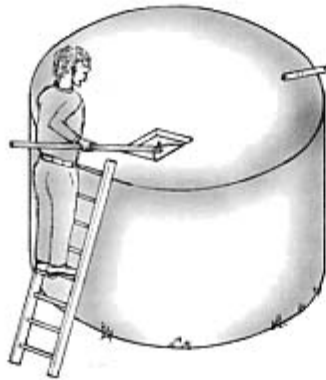

Steep Roofs

Levetator can accommodate angles of 45° or more. However you will have to make a slight compensation when marking out the holes. The hole positions marked on the template are correct for flat or slight slopes - for steep slopes the cord holes have to be moved nearer to the edge of the tank so that the cords will be central in the holes and won't chafe.

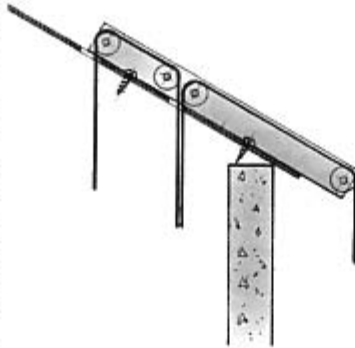

Tanks without Roofs

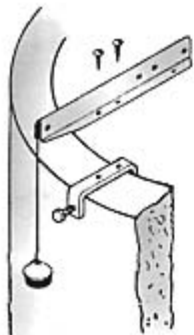

For open top concrete tanks a "G-Clamp" mounting bracket is available. It simply clamps on the tank wall and the Levetator is screwed to the clamp.

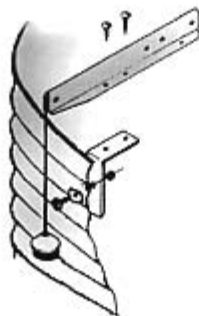

For thin wall tanks (e.g. Corrugated Iron) an "L" type bracket is available. The bracket is screwed to two holes drilled in the tank wall, and the Levetator is screwed to the bracket.

Extension Price

This nearly doubles the length of the pulley housing, providing more distance between the float and counterpoise. The position of the counterpoise can be altered too, by relocating the pair of pulleys. Axle holes will have to be drilled (6.5mm diameter) for this purpose in the desired location and deburred. This option is particularly suitable for tanks with liners which may have large folds or bulges.

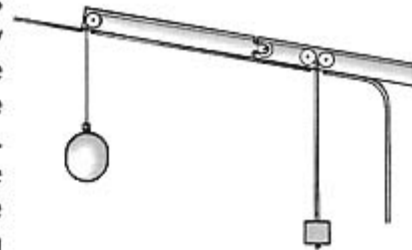

Barrel - shaped tanks

Levetators have been designed to provide enough room for the tank wall, whether barrel-shaped or thick concrete. On barrel-shaped tanks, simply mount it further out (up to 150mm) to give sufficient clearance for the indicator, using the alternative screw hole.

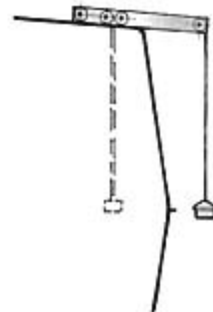
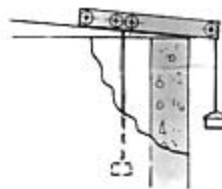

Wind Guards

Even strong winds do not usually adversely affect the Levetator - it may cause the indicator to sway a little, but it usually doesn't come into contact with the tank.

However, it is not difficult to make a wind guard - either a sheet metal channel or 90mm dia. PVC stormwater pipe with a slot cut down the length.

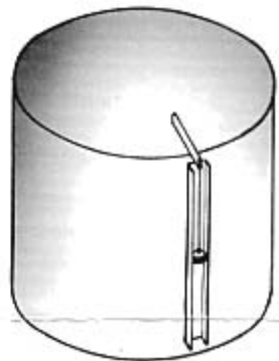

PVC PIPE

Alternatively, a Liquidator which has a captive, guided indicator can be used instead.

Domed Roofs

If the Levetator won't sit nicely on curved or dome-shaped roofs, use packing washers as necessary to compensate for the curvature.

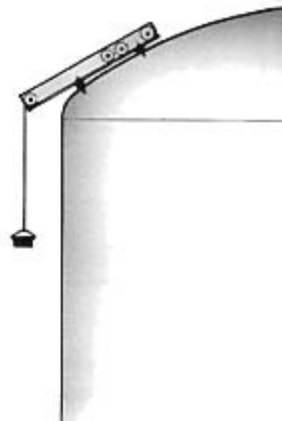

TROUBLESHOOTING

Mounting Screw Hassles

If it is not possible to make a small neat hole for the mounting screws don't worry. Toggle bolts, available from most hardware shops, will solve the problem.

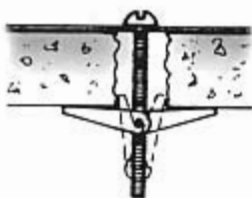

Turbulence

Excessive water movement may give rise to twisting or tangling. Usually this is due to the turbulence or swirl from pumping, particularly if the pump inlet is near the Levetator. If the pipework can't be altered, then install a baffle to prevent water movement from disturbing the Levetator float and counterpoise.

Twisted Cords

If the cords supporting the counterpoise are twisted together, the Levetator will not run freely, so take care during installation.

Even though the cords are under tension they can still remain twisted together. This is due to "self-twist" of the individual cords and the solution is to undo the knot, separate the two cords (cut if necessary) and allow any residual twist from each one to "fall out".

If the problem persists then a small rod fitted as shown should solve the problem. One customer found it to be the answer to twisting caused by children pulling on the indicator. The small smooth rod or pin separates the cords thereby removing the twist so the individual cords run freely onto the pulleys.



Animals

Cattle have been known to nudge the indicator and sometimes to chew the cord. If necessary you can protect the indicator by driving a pair of steel star pickets, one on each side. Spirally wrapping the pickets with barbed wire is very effective. Alternatively, one of the wind guards described above will do the trick also.

One farmer had a problem with cockatoos perching on the Levetator and chewing the cord. The solution was to fit a metal cover over the end (like a verandah), so the cockatoos couldn't get at it.

Another customer had a frog that liked to sit on the float. Fortunately it wasn't heavy enough to upset the balance.

Sticking

Sometimes, when the tank level hasn't changed for a long time, the Levetator may be reluctant to move. This may just be a build up of dust, perhaps a spider web, or mud wasps. Whatever the cause, it can usually be fixed simply by "tweaking" the cord to free up the mechanism. (Water can be used to clean the inside, but never use oil - it will attract dust and gum up).

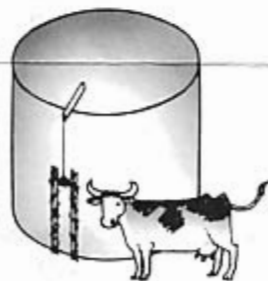

FREQUENTLY ASKED QUESTIONS (FAQ)

Can the Levetator be used with other liquids?

Levetators can and have been used with other liquids, but the Liquidator which has been designed for such applications is recommended.

Does the Levetator need any maintenance?

Not really, they are built to last. The only item that may need maintenance is the polyester cord, but it is UV resistant and should last for many years before needing renewal. (The first Levetator, fitted in 1985, still has its original cord!)

However, if the cord does show signs of deterioration, renew it, before it finally gives way (so that you don't have to retrieve the counterpoise from the bottom of the tank).

Nevertheless, if you do need any spare parts, they are available from Yaktek Industries.

Is there an alternative to the polyester cord?

Yes, a nylon coated stainless steel wire is available as an option, or accessory.

Is it suitable for underground tanks?

No, because the indicator is always at true water level, and you'd have to dig a tunnel to see it!

For these situations the Dipstik is recommended.

Warranty

Any component found to be defective due to faulty material or workmanship within 5 years of purchase will be replaced free of charge (polyester cord excepted).



36 Lewis Road, Maldon, Vic., 3463, Australia.

Phone: +61 (0)3 5475 1116

Fax: +61 (0)3 5475 1126

Web: www.yaktek.com.au